

# DT-4,8

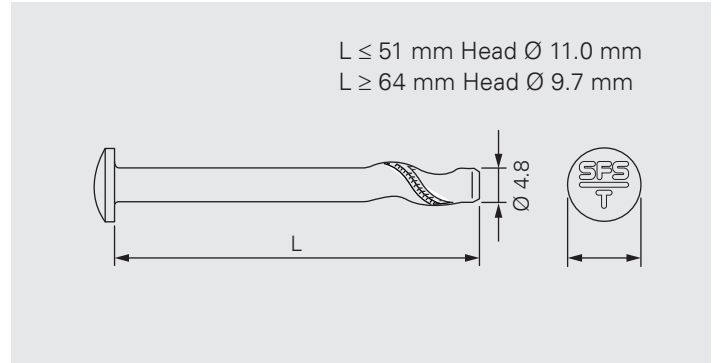

## Application

Carbon steel impact anchor for waterproof membrane and insulation securement on concrete deck.

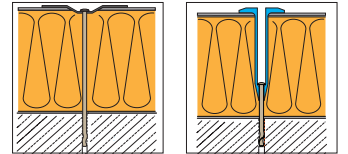

Substrate material quality:	min. C12/15
Substrate material thickness:	min. 60 mm
Pre-drill diameter:	4.8 mm
Setting depth:	min. 25 mm
Depth of pilot hole:	min. 15 mm deeper than setting depth

## Product Information

Material:	Case hardened carbon steel
Corrosion protection:	Durocoat® Resistance 15 cycles Kesternich test according to <ul style="list-style-type: none"> <li>EAD 030351-00-0402, A2.4</li> <li>FM Approval Standard 4470</li> </ul>

## Approvals/Assessments



Declaration of Performance (DoP)







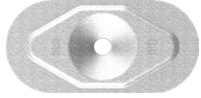

### Features and Benefits

- Fast and easy installation, pre-drill and hammer
- Plug free installation
- Fire and vibration resistant
- High quality corrosion protection, environment friendly, free of Chromium VI

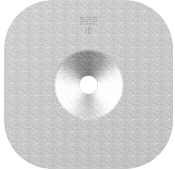





### Product Range

Product Code	L <sub>mm</sub>	PU	Material No.
DT-4,8×28	28	500	516443
DT-4,8×32	32	500	516445
DT-4,8×38	38	500	516447
DT-4,8×51	51	500	516451
DT-4,8×64	64	500	516453
DT-4,8×76	76	500	516457
DT-4,8×89	89	250	516461
DT-4,8×102	102	250	516463
DT-4,8×115	115	250	516465
DT-4,8×127	127	100	516467
DT-4,8×140	140	100	516469
DT-4,8×152	152	100	516470

## Products to combine with

Product Code	Description	
IRD-82×40	Stress plate for waterproof membrane and insulation securement. For seam fastening application.	
IF/IG-C-82×40	Convex stress plate for waterproof membrane and insulation securement. For seam fastening application, on hard substrate.	
ID-70×70	Stress plate for insulation securement.	
FI-P-6,8	Stress plates for PVC, TPO and EPDM based waterproof membranes. For isoweld® field fastening application.	
R48	Sleeve with 3 peaks for waterproof membrane and insulation securement. For seam fastening application.	
R50	Sleeve for waterproof membrane and insulation securement. For seam fastening application.	
R75	Sleeve for insulation securement.	
FI-R-20	Sleeve for waterproof membrane and insulation securement. For isoweld® field fastening and seam fastening applications.	

## Tools and Accessories

Product Code	Description	
SDS-4,8xL/L-SP	SDS drill bit	
ZVK-4,8xLxL	Conus drill bit for combination with ZAK drill extension	
ZVK-4,8xLxL-STOP	Conus drill bit with stop function for combination with ZAK drill extension	
ZAK-500 ZAK-750 ZAK1000	Drill extension for ZVK conus drill bits, length 500, 750 and 1000 mm	
ZD15	Installation tool for impact anchor DT-4,8, DT-S-4,8 and DT-6,3	
DT-M-500 DT-M-750	Installation tool for impact anchor DT-4,8, DT-S-4,8 in combination with sleeve for the use with SDS hammer drill, length 500 and 750 mm	

## Recommendations for Installation

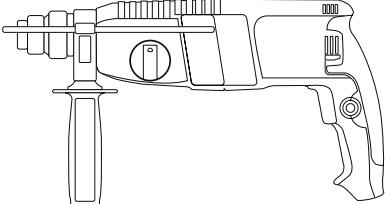
Operating process	Recommendation	
Pre-drilling	Hammer drill with weight class 2–3 kg, impact energy $\leq 2,5$ J	
Installation impact anchor with DT-M-500 and DT-M-750 in combination with sleeve	Hammer drill with weight class 2–3 kg, impact energy $\leq 2,5$ J, hammer function without rotation	