

# DT-6,3

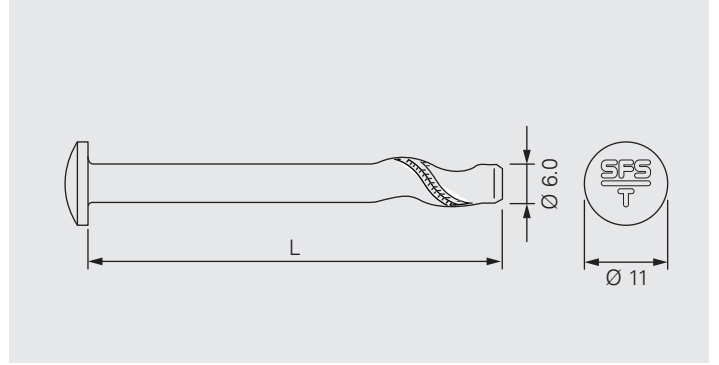

## Application

Carbon steel impact anchor for waterproof membrane and insulation securement on concrete deck.

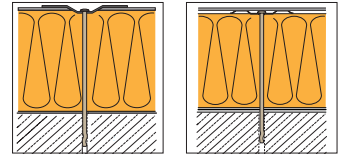

Substrate material quality:	min. C12/15
Substrate material thickness:	min. 60 mm
Pre-drill diameter:	6.3 mm
Setting depth:	min. 32 mm
Depth of pilot hole:	min. 15 mm deeper than setting depth

## Product Information

Material:	Case hardened carbon steel
Corrosion protection:	Durocoat® Resistance 15 cycles Kesternich test according to <ul style="list-style-type: none"> <li>• EAD 030351-00-0402, A2.4</li> <li>• FM Approval Standard 4470</li> </ul>

## Approvals/Assessments



Declaration of Performance (DoP)





## Features and Benefits

- Fast and easy installation, pre-drill and hammer
- Plug free installation
- Fire and vibration resistant
- FM approved
- High quality corrosion protection, environment friendly, free of Chromium VI

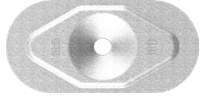

## Product Range

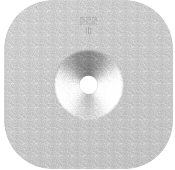
Product Code	L <sub>mm</sub>	PU	Material No.
DT-6,3×38	38	250	500775
DT-6,3×51	51	250	500778
DT-6,3×102	102	250	533566
DT-6,3×140	140	100	500782
DT-6,3×152	152	100	500785
DT-6,3×165	165	100	500790
DT-6,3×178	178	100	500793
DT-6,3×191	191	100	500796
DT-6,3×203	203	100	500798
DT-6,3×216	216	50	500801
DT-6,3×229	229	50	500804
DT-6,3×241	241	50	500808
DT-6,3×254	254	50	500810
DT-6,3×267	267	50	500812
DT-6,3×279	279	50	500814
DT-6,3×292	292	50	500816
DT-6,3×305	305	50	500819
DT-6,3×330	330	50	500821
DT-6,3×356	356	50	500823
DT-6,3×381	381	50	500825
DT-6,3×406	406	50	500827
DT-6,3×432	432	50	500829

## Products to combine with

Product Code	Description	
IRD-82×40	Stress plate for waterproof membrane and insulation securement. For seam fastening application.	
IF/IG-C-82×40	Convex stress plate for waterproof membrane and insulation securement. For seam fastening application, on hard substrate.	
ID-70×70	Stress plate for insulation securement.	
FI-P-6,8	Stress plates for PVC, TPO and EPDM based waterproof membranes. For isoweld® field fastening application.	

## Tools and Accessories

Product Code	Description	
SDS-6,3×L/L-SP	SDS drill bit	
ZD15	Installation tool for impact anchor DT-4,8, DT-S-4,8 and DT-6,3	

## Recommendations for Installation

<b>Operating process</b>	<b>Recommendation</b>	
Pre-drilling	Hammer drill with weight class 2–3 kg, impact energy $\leq 2,5$ J	