

DT-S-4,8

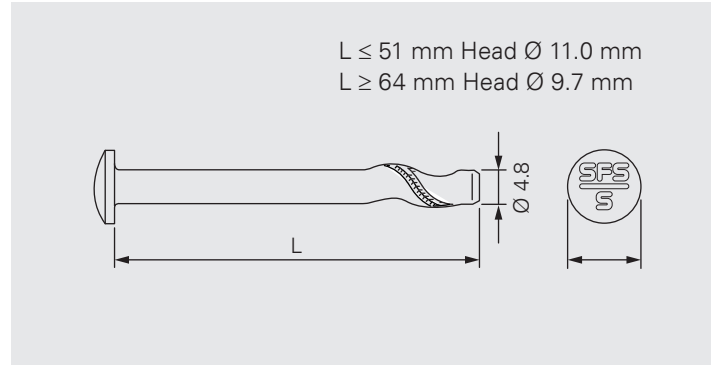

Application

Stainless steel impact anchor for waterproof membrane and insulation securement on concrete deck. For applications with increased requirements, such as high relative humidity, chemical aggressive atmospheres or conditions (e.g. coastal environments). For refurbishments with unknown condition of the existing build-up or build-up with abrasive layers that may damage the corrosion protection. If extended design life and/or warranty is required.

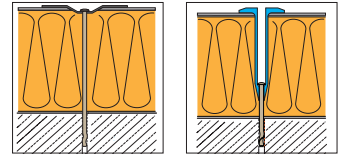

Substrate material quality:	min. C12/15
Substrate material thickness:	min. 60 mm
Pre-drill diameter:	4.8 mm
Setting depth:	min. 25 mm
Depth of pilot hole:	min. 15 mm deeper than setting depth

Product Information

Material: Austenitic stainless steel, European standard 1.4401, grade A4, AISI 316

Approvals/Assessments



Declaration of Performance (DoP)







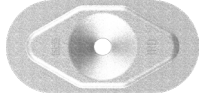

Features and Benefits

- Stainless steel quality A4, 1.4401, AISI 316
 - Fast and easy installation, pre-drill and hammer
 - Plug free installation
 - Fire and vibration resistant
 - Environment friendly, free of Chromium VI
-

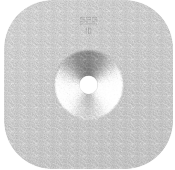





Product Range

Product Code	L_{mm}	PU	Material No.
DT-S-4,8×28	28	500	500831
DT-S-4,8×32	32	500	500833
DT-S-4,8×38	38	500	500842
DT-S-4,8×51	51	500	500849
DT-S-4,8×64	64	500	500851
DT-S-4,8×89	89	250	500854

Products to combine with

Product Code	Description	
IRD-82×40	Stress plate for waterproof membrane and insulation securement. For seam fastening application.	
IF/IG-C-82×40	Convex stress plate for waterproof membrane and insulation securement. For seam fastening application, on hard substrate.	
ID-70×70	Stress plate for insulation securement.	
FI-P-6,8	Stress plates for PVC, TPO and EPDM based waterproof membranes. For isoweld® field fastening application.	
R48	Sleeve with 3 peaks for waterproof membrane and insulation securement. For seam fastening application.	
R50	Sleeve for waterproof membrane and insulation securement. For seam fastening application.	
R75	Sleeve for insulation securement.	
FI-R-20	Sleeve for waterproof membrane and insulation securement. For isoweld® field fastening and seam fastening applications.	

Tools and Accessories

Product Code	Description	
SDS-4,8xL/L-SP	SDS drill bit	
ZVK-4,8xLxL	Conus drill bit for combination with ZAK drill extension	
ZVK-4,8xLxL-STOP	Conus drill bit with stop function for combination with ZAK drill extension	
ZAK-500 ZAK-750 ZAK1000	Drill extension for ZVK conus drill bits, length 500, 750 and 1000 mm	
ZD15	Installation tool for impact anchor DT-4,8, DT-S-4,8 and DT-6,3	
DT-M-500 DT-M-750	Installation tool for impact anchor DT-4,8, DT-S-4,8 in combination with sleeve for the use with SDS hammer drill, length 500 and 750 mm	

Recommendations for Installation

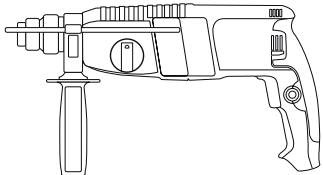
Operating process	Recommendation	
Pre-drilling	Hammer drill with weight class 2–3 kg, impact energy $\leq 2,5$ J	
Installation impact anchor with DT-M-500 and DT-M-750 in combination with sleeve	Hammer drill with weight class 2–3 kg, impact energy $\leq 2,5$ J, hammer function without rotation	