

TIF-N-6,3

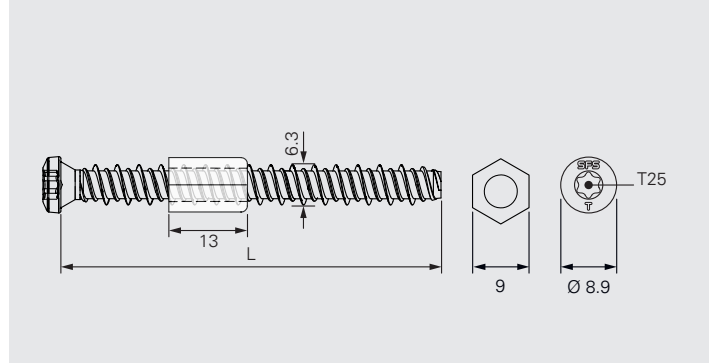
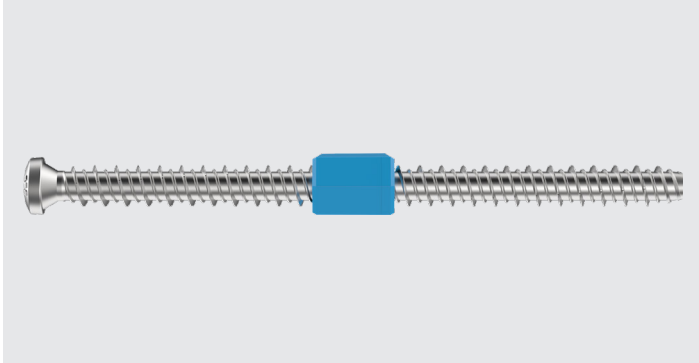

Application

Adjustable carbon steel fastener for waterproof membrane and tapered insulation securement in combination with sleeve RH50 on concrete deck, with telescope-function.

Substrate material quality:	min. C12/15
Substrate material thickness:	min. 40 mm
Pre-drill diameter:	5.0 mm, see "Tools and Accessories" for alternative drill diameters
Setting depth:	min. 20 mm
Depth of pilot hole:	min. 15 mm deeper than setting depth

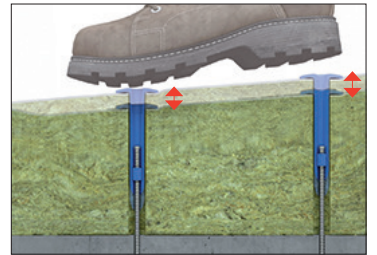

Product Information

Material:	Case hardened carbon steel
Corrosion protection:	Durocoat® Resistance 15 cycles Kesternich test according to <ul style="list-style-type: none"> • EAD 030351-00-0402, A2.4 • FM Approval Standard 4470

Approvals/Assessments



Declaration of Performance (DoP)

Features and Benefits

- Adjustable fastening system for tapered insulation with telescopic function
- Fewer product combinations required
- Only 20 mm setting depth required, ideal for thin concrete deck
- High quality corrosion protection, environment friendly, free of Chromium VI

Product Range









Pre-assembled sleeve-fastener combination, fastener incl. plastic nut

Product Code	Clamping length KL		PU	Material No.
	min. mm	max. mm		
RH50×85/TIF-N-6,3×100	100	130	250	1572985
RH50×105/TIF-N-6,3×100	130	160	250	1572986
RH50×135/TIF-N-6,3×160	160	230	250	1319570
RH50×185/TIF-N-6,3×160	215	280	250	1319580
RH50×255/TIF-N-6,3×160	285	350	250	1319591
RH50×325/TIF-N-6,3×160	355	420	250	1319595
RH50×405/TIF-N-6,3×160	435	500	250	1319596
RH50×485/TIF-N-6,3×160	515	580	250	1319597
RH50×565/TIF-N-6,3×160	595	660	200	1319598
RH50×645/TIF-N-6,3×160	675	740	200	1319599
RH50×705/TIF-N-6,3×160	735	800	200	1319600

Products to combine with

Product Code	Description	
RH50	Sleeve for waterproof membrane and insulation securement in combination with fastener TIF-N-6,3. For seam fastening application.	

Tools and Accessories

Product Code	Description	
SDS-5,0xL/L-SP SDS-4,8xL/L-SP* SDS-5,2xL/L-SP*	SDS drill bit	
ZVK-5,0xLxL ZVK-4,8xLxL * ZVK-5,2xLxL *	Conus drill bit for combination with ZAK drill extension	
ZVK-5,0xLxL-STOP ZVK-4,8xLxL-STOP * ZVK-5,2xLxL-STOP *	Conus drill bit with stop function for combination with ZAK drill extension	
ZAK-500 ZAK-750 ZAK1000	Drill extension for ZVK conus drill bits, length 500, 750 and 1000 mm	
ZA¼"-M6-300 ZA¼"-M6-750	Drive bar for installation of fastener and sleeve, length 300 mm and 750 mm	
ZA¼"-M6-EXT	Drive bar extension, length 100 mm	
T25-32-M6	Insert bit with T25 drive	
AJ-M6	Bit for height adjustment of sleeve in combination with fasteners TIA-T25-6,3 and TIF-N-6,3	
AJ60x130-TIA	Installation tool for manual height adjustment of sleeve in combination with fasteners TIA-T25-6,3 and TIF-N-6,3	

* Alternative drill diameter depending on local conditions. The optimum drill diameter can be determined via on-site pull-out tests.

Recommendations for Installation

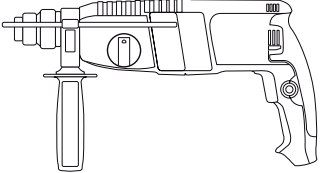
Operating process	Recommendation	
Pre-drilling	Hammer drill with weight class 2–3 kg, impact energy $\leq 2,5$ J	
Screwing in	Power screwdriver <ul style="list-style-type: none"> • 300–700 rpm • Min. 500 W Battery tool <ul style="list-style-type: none"> • 300–700 rpm • Min. 18 V • Battery with min. 2,5 Ah Do not use a percussion tool	