

TS-T25-6,0

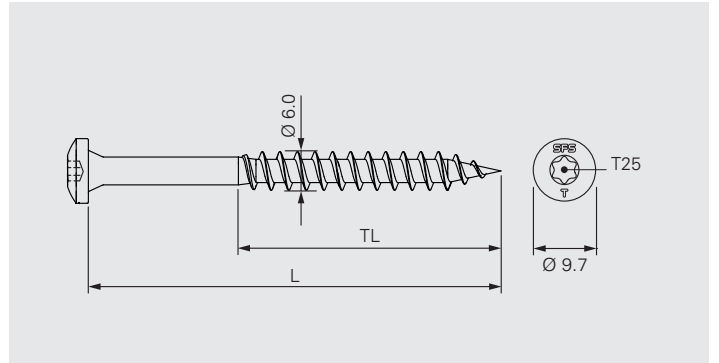
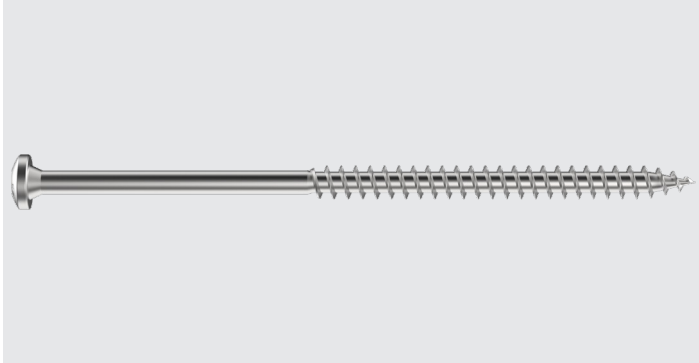

Application 1

Carbon steel fastener for waterproof membrane and insulation securement on timber and timber-based boards.

Substrate material thickness: min. 18 mm
 Setting depth: min. 25 mm

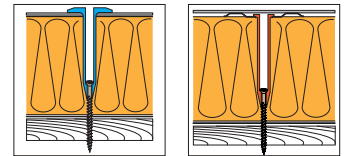

Application 2

Carbon steel fastener for waterproof membrane and insulation securement on concrete deck.

Substrate material quality: min. C12/15
 Pre-drill diameter: 5.0 mm
 Setting depth: min. 50 mm
 Depth of pilot hole: min. 15 mm deeper than setting depth

Product Information

Material: Case hardened carbon steel

Corrosion protection: Durocoat®
 Resistance 15 cycles Kesternich test according to

- EAD 030351-00-0402, A2.4
- FM Approval Standard 4470

Approvals/Assessments



ETA-08/0262

Declaration of Performance (DoP)





Features and Benefits

- Special thread provides high pull-out values
- Fast and easy installation due to sharp tip
- High quality corrosion protection, environment friendly, free of Chromium VI







Product Range

Product Code	L _{mm}	TL _{mm}	PU	Material No.
TS-T25-6,0×50	50	44	1000	1352258
TS-T25-6,0×60	60	54	500	1352259
TS-T25-6,0×70	70	64	500	1352260
TS-T25-6,0×80	80	70	500	1352261
TS-T25-6,0×90	90	70	500	1352262
TS-T25-6,0×100	100	70	500	1352263
TS-T25-6,0×110	110	70	500	1352264
TS-T25-6,0×120	120	70	500	1352265
TS-T25-6,0×130	130	70	250	1702209
TS-T25-6,0×140	140	70	250	1352267
TS-T25-6,0×160	160	70	250	1352268
TS-T25-6,0×180	180	70	250	1352269
TS-T25-6,0×200	200	70	250	1352270
TS-T25-6,0×220	220	70	250	1352271
TS-T25-6,0×240	240	70	250	1352272

Products to combine with

Product Code	Description	
FI-P-6,8	Stress plates for PVC, TPO and EPDM based waterproof membranes. For isoweld® field fastening application.	
R48	Sleeve with 3 peaks for waterproof membrane and insulation securement. For seam fastening application.	
R50	Sleeve for waterproof membrane and insulation securement. For seam fastening application.	
R75	Sleeve for insulation securement.	
FI-R-20	Sleeve for waterproof membrane and insulation securement. For isoweld® field fastening and seam fastening applications.	

Tools and Accessories

Product Code	Description	
ZA¼"-M6-300 ZA¼"-M6-750	Drive bar for installation of fastener and sleeve, length 300 mm and 750 mm	
ZA¼"-M6-EXT	Drive bar extension, length 100 mm	
T25-32-M6	Insert bit with T25 drive	
ZH-11-RING	Adapter to hold sleeves R48, R50, R75 onto drive bar	
ZH-12-RING	Adapter to hold sleeve FI-R-20 onto drive bar	
Bit holder ZA¼"	Bit holder for bits with HEX shaft	
T25-25-HEX¼"	Insert bit with T25 drive and HEX shaft	

Recommendations for Installation

Operating process	Recommendation	
Screwing in	<p>Power screwdriver</p> <ul style="list-style-type: none"> • 300–700 rpm • Min. 500 W <p>Battery tool</p> <ul style="list-style-type: none"> • 300–700 rpm • Min. 18 V • Battery with min. 2,5 Ah <p>Do not use a percussion tool</p>	