

ID-70x70

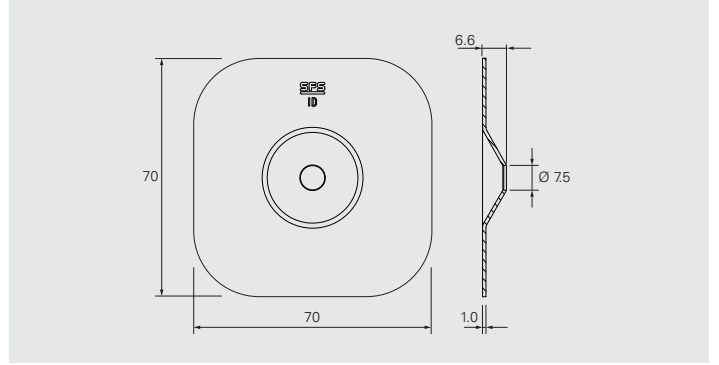

Application

Stress plate for insulation securement.

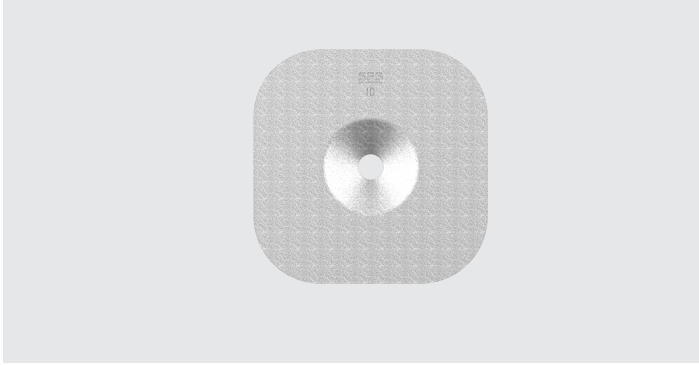
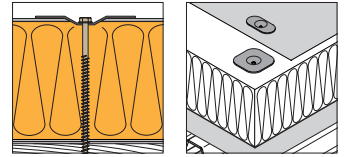

Product Information

Material:	Carbon steel, zinc plated
Corrosion protection:	Resistance 15 cycles Kesternich test according to <ul style="list-style-type: none"> • EAD 030351-00-0402, A2.4 • FM Approval Standard 4470

Approvals/Assessments









Declaration of Performance (DoP)

Product Range

Product Code	PU	Material No.
ID-70x70	100	1340194

Products to combine with

Product Code	Description	
DT-4.8	Carbon steel impact anchor for concrete deck.	
DT-S-4.8	Stainless steel impact anchor for concrete deck.	
DT-6,3	Carbon steel impact anchor for concrete deck.	
TI-6,3	Carbon steel fastener for concrete deck.	
LBS-T25-8,0	Carbon steel fastener for aerated concrete deck.	
LBS-S-T25-8,0	Stainless steel fastener for aerated concrete deck.	
IG-6,0	Carbon steel fastener for timber and timber-based boards.	
TPR-L-6,3	Peel Rivet for critical decks.	