

IF/IG-C-82x40

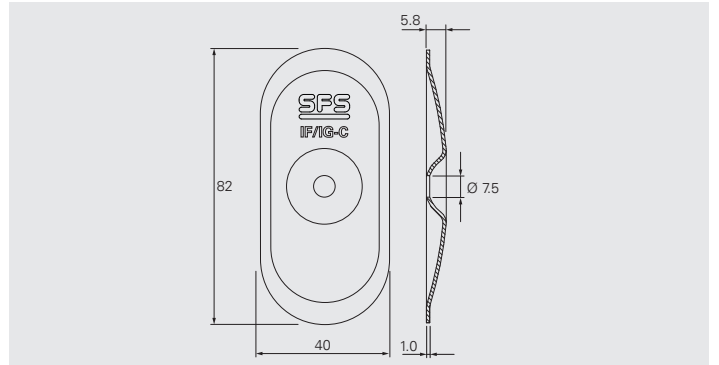

Application

Convex stress plate for waterproof membrane and insulation securement.
For seam fastening application, on hard substrate.

Product Information

Material:	Carbon steel, zinc plated
Corrosion protection:	Resistance 15 cycles Kesternich test according to <ul style="list-style-type: none">• EAD 030351-00-0402, A2.4• FM Approval Standard 4470

Approvals/Assessments

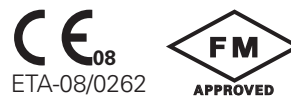









Declaration of Performance (DoP)

Product Range

Product Code	PU	Material No.
IF/IG-C-82x40	100	1333674

Products to combine with

Product Code	Description	
DT-4.8	Carbon steel impact anchor for concrete deck.	
DT-S-4.8	Stainless steel impact anchor for concrete deck.	
DT-6,3	Carbon steel impact anchor for concrete deck.	
TI-6,3	Carbon steel fastener for concrete deck.	
LBS-T25-8,0	Carbon steel fastener for aerated concrete deck.	
LBS-S-T25-8,0	Stainless steel fastener for aerated concrete deck.	
IG-6,0	Carbon steel fastener for timber and timber-based boards.	
IWF-5,2	Carbon steel fastener for timber and timber-based boards.	
IW-S-5,0	Stainless steel fastener for timber and timber-based boards.	
TPR-L-6,3	Peel Rivet for critical decks.	