

# FI-R-20

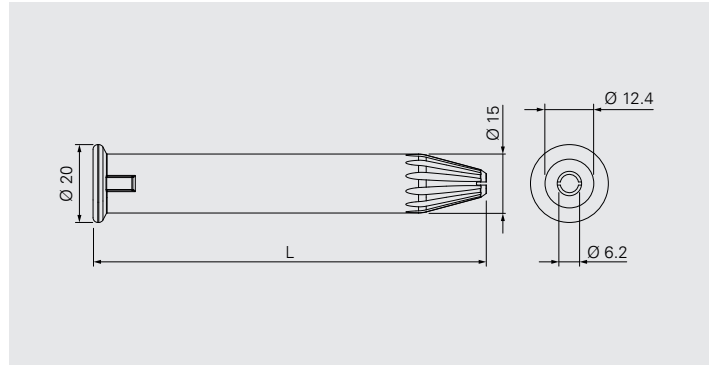

## Application

Sleeve for waterproof membrane and insulation securement.  
For isoweld® field fastening and seam fastening applications.

Overlap length between sleeve and fastener: 15 mm

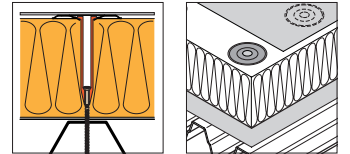

## Product Information

Material: High quality polyamide (PA6)

## Approvals/Assessments

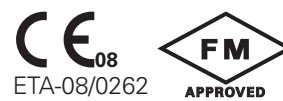

Declaration of Performance (DoP)















## Features and Benefits

- Heat resistant material for the isoweld induction system
- Sleeve tip enables pre-assembling with different fasteners
- Optimized sleeve tip for reduced penetration force
- Universal sleeve design for various applications and combinations





## Product Range

Product Code	L <sub>mm</sub>	PU	Material No.
FI-R-20×40	40	500	1524375
FI-R-20×70	70	500	1524439
FI-R-20×100	100	500	1513274
FI-R-20×130	130	500	1524447
FI-R-20×160	160	250	1524449
FI-R-20×190	190	250	1524450
FI-R-20×230	230	250	1524462
FI-R-20×300	300	250	1524463

## Products to combine with

Product Code	Description	
BS-4,8	Carbon steel fastener for steel deck, timber and timber-based boards	
BS3-4,8	Carbon steel fastener for thick steel deck	
BS-S-4,8	Stainless steel fastener for steel deck, timber and timber-based boards	
BS-6,1	Carbon steel fastener for steel deck, timber and timber-based boards	
BS-S-6,1	Stainless steel fastener for steel deck, timber and timber-based boards	
BSA-N-4,8	Adjustable carbon steel fastener for tapered insulation on steel deck, with telescope-function	
DT-4,8	Carbon steel impact anchor for concrete deck	
DT-S-4,8	Stainless steel impact anchor for concrete deck	
TI-T25-6,3	Carbon steel fastener for concrete deck	
TIA-T25-6,3	Adjustable carbon steel fastener for tapered insulation on concrete deck	
TS-T25-6,0	Carbon steel fastener for timber, timber-based boards and concrete deck	
FI-P-16,0	Stress plates for PVC, TPO and EPDM based waterproof membranes in combination with sleeve FI-R-20. For isoweld® field fastening application.	
BSA-P-50	Stress plate for waterproof membrane and insulation securement in combination with sleeve FI-R-20. For seam fastening application.	
BSA-P-70x70	Stress plate for insulation securement in combination with sleeve FI-R-20.	

## Tools and Accessories

Product Code	Description	
ZA¼"-M6-300 ZA¼"-M6-750	Drive bar for installation of fastener and sleeve, length 300 mm and 750 mm	
ZA¼"-M6-EXT	Drive bar extension, length 100 mm	
T25-32-M6	Insert bit with T25 drive	
ZH-12-RING	Adapter to hold sleeve FI-R-20 onto drive bar	
AJ-M6	Bit for height adjustment of sleeve in combination with fasteners TIA-T25-6,3 and TIF-N-6,3	
AJ60x130-TIA	Installation tool for manual height adjustment of sleeve in combination with fasteners TIA-T25-6,3 and TIF-N-6,3	