

R48

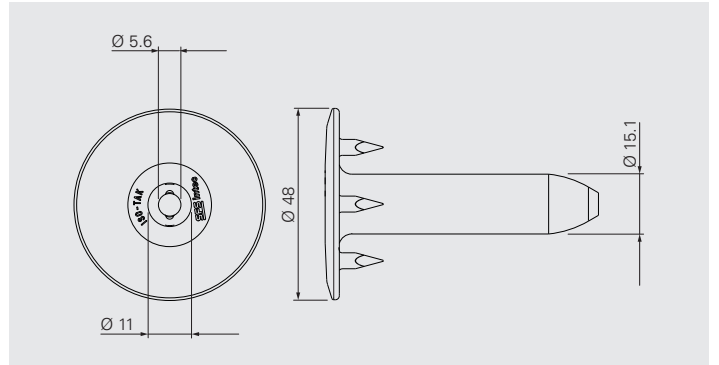

Application

Sleeve with 3 peaks for waterproof membrane and insulation securement.
For seam fastening application.

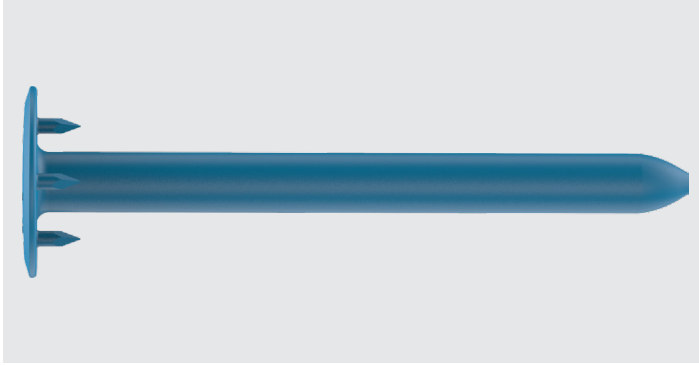
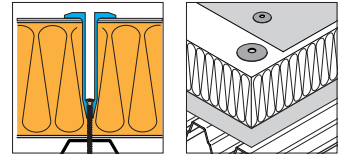

Overlap length between sleeve and fastener: 13 mm

Product Information

Material: High quality polypropylen (PP)

Approvals/Assessments



Declaration of Performance (DoP)







Features and Benefits

- High performance sleeve with 3 peaks provides high design values
- FM Approval
- Sleeve tip enables pre-assembling with different fasteners
- Universal sleeve for several applications and combinations



Product Range

Product Code	L _{mm}	PU	Material No.
R48×65	65	500	527614
R48×85	85	500	527634
R48×105	105	500	527635
R48×135	135	500	527636
R48×165	165	500	527637
R48×185	185	500	527638
R48×225	225	250	527639
R48×255	255	250	1277760
R48×285	285	250	1274841
R48×325	325	250	1277758
R48×365	365	250	1277771
R48×405	405	250	1277772
R48×485	485	250	1278130
R48×565	565	250	1278132
R48×645	645	200	1278137
R48×705	705	200	1278153

Products to combine with

Product Code	Description	
BS-4,8	Carbon steel fastener for steel deck and timber and timber-based boards.	
BS-S-4,8	Stainless steel fastener for steel deck and timber and timber-based boards.	
BS3-4,8	Carbon steel fastener for thick steel deck.	
BS-6,1	Carbon steel fastener for steel deck and timber and timber-based boards.	
BS-S-6,1	Stainless steel fastener for steel deck and timber and timber-based boards.	
DT-4,8	Carbon steel impact anchor for concrete deck.	
DT-S-4,8	Stainless steel impact anchor for concrete deck.	
TI-T25-6,3	Carbon steel fastener for concrete deck.	
TS-T25-6,0	Carbon steel fastener for timber and timber-based boards and concrete deck.	

Tools and Accessories

Product Code	Description	
ZA¼"-M6-300 ZA¼"-M6-750	Drive bar for installation of fastener and sleeve, length 300 mm and 750 mm	
ZA¼"-M6-EXT	Drive bar extension, length 100 mm	
T25-32-M6	Insert bit with T25 drive	
ZH-11-RING	Adapter to hold sleeves R48, R50, R75 onto drive bar	