

R75

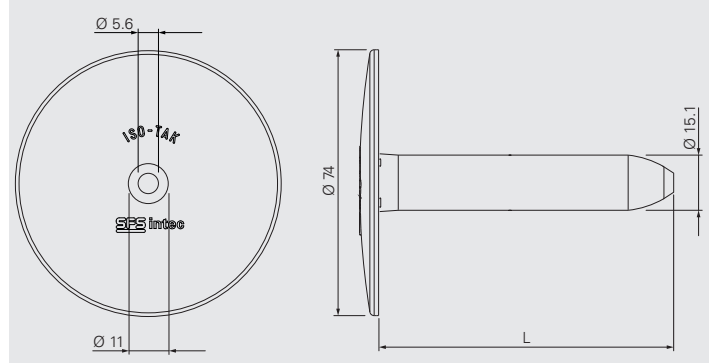

Application

Sleeve for insulation securement.

Overlap length between sleeve and fastener: 13 mm

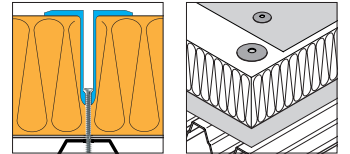

Product Information

Material: High quality polypropylen (PP)

Approvals/Assessments



Declaration of Performance (DoP)









Features and Benefits

- Designed for insulation securement
- Sleeve tip enables pre-assembling with different fasteners
- Universal sleeve for several applications and combinations





Product Range

Product Code	L _{mm}	PU	Material No.
R75×35	35	500	1037831
R75×65	65	500	1037833
R75×85	85	500	1041226
R75×105	105	500	1037836
R75×135	135	500	1037838
R75×165	165	250	1037839
R75×185	185	250	1037840
R75v225	225	250	1037842
R75×255	255	250	1037843
R75×285	285	200	1037844

Products to combine with

Product Code	Description	
BS-4,8	Carbon steel fastener for steel deck and timber and timber-based boards.	
BS-S-4,8	Stainless steel fastener for steel deck and timber and timber-based boards.	
BS3-4,8	Carbon steel fastener for thick steel deck.	
BS-6,1	Carbon steel fastener for steel deck and timber and timber-based boards.	
BS-S-6,1	Stainless steel fastener for steel deck and timber and timber-based boards.	
DT-4,8	Carbon steel impact anchor for concrete deck.	
DT-S-4,8	Stainless steel impact anchor for concrete deck.	
TI-T25-6,3	Carbon steel fastener for concrete deck.	
TIA-T25-6,3	Adjustable carbon steel fastener for tapered insulation on concrete deck.	
TS-T25-6,0	Carbon steel fastener for timber and timber-based boards and concrete deck.	

Tools and Accessories

Product Code	Description	
ZA¼"-M6-300 ZA¼"-M6-750	Drive bar for installation of fastener and sleeve, length 300 mm and 750 mm	
ZA¼"-M6-EXT	Drive bar extension, length 100 mm	
T25-32-M6	Insert bit with T25 drive	
ZH-11-RING	Adapter to hold sleeves R48, R50, R75 onto drive bar	
AJ-M6	Bit for height adjustment of sleeve in combination with fasteners TIA-T25-6,3 and TIF-N-6,3	
AJ60x130-TIA	Installation tool for manual height adjustment of sleeve in combination with fasteners TIA-T25-6,3 and TIF-N-6,3	