

RH50

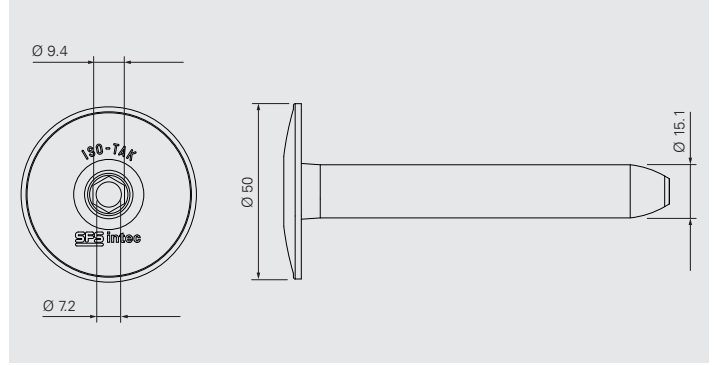

Application

Sleeve for waterproof membrane and insulation securement in combination with fastener TIF-N-6,3. For seam fastening application.

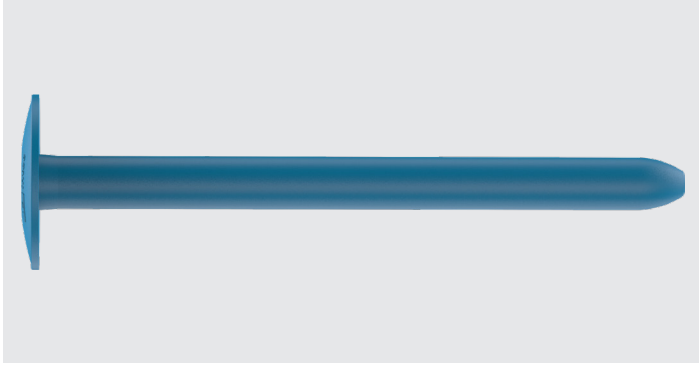
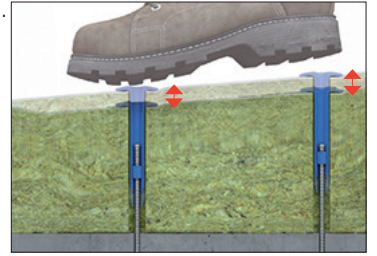

Product Information

Material: High quality polypropylen (PP)

Approvals/Assessments



Declaration of Performance (DoP)

Features and Benefits

- Adjustable fastening system for tapered insulation with telescope-function
- In combination with fastener TIF-N-6,3
- 50 mm head diameter provides high design values

Product range





Pre-assembled sleeve-fastener combination, fastener incl. plastic nut

Product Code	Clamping length KL		PU	Material No.
	min. mm	max. mm		
RH50×85/TIF-N-6,3×100	100	130	250	1572985
RH50×105/TIF-N-6,3×100	130	160	250	1572986
RH50×135/TIF-N-6,3×160	160	230	250	1319570
RH50×185/TIF-N-6,3×160	215	280	250	1319580
RH50×255/TIF-N-6,3×160	285	350	250	1319591
RH50×325/TIF-N-6,3×160	355	420	250	1319595
RH50×405/TIF-N-6,3×160	435	500	250	1319596
RH50×485/TIF-N-6,3×160	515	580	250	1319597
RH50×565/TIF-N-6,3×160	595	660	200	1319598
RH50×645/TIF-N-6,3×160	675	740	200	1319599
RH50×705/TIF-N-6,3×160	735	800	200	1319600

Products to combine with

Product Code	Description	
TIF-N-6,3	Adjustable carbon steel fastener for tapered insulation on concrete deck, with telescope-function.	

Tools and Accessories

Product Code	Description	
ZA $\frac{1}{4}$ "-M6-300 ZA $\frac{1}{4}$ "-M6-750	Drive bar for installation of fastener and sleeve, length 300 mm and 750 mm	
ZA $\frac{1}{4}$ "-M6-EXT	Drive bar extension, length 100 mm	
T25-32-M6	Insert bit with T25 drive	
AJ-M6	Bit for height adjustment of sleeve in combination with fasteners TIA-T25-6,3 and TIF-N-6,3	
AJ60x130-TIA	Installation tool for manual height adjustment of sleeve in combination with fasteners TIA-T25-6,3 and TIF-N-6,3	